

DEARBORN RIGID SHANK *Cultivators*

MODELS 13-1 and 13-3

Group 2—DEARBORN RIGID SHANK CULTIVATOR (Lift Type)—Model 13-1 DEARBORN RIGID SHANK FRONT-END CULTIVATOR ATTACHMENT—Model 13-3

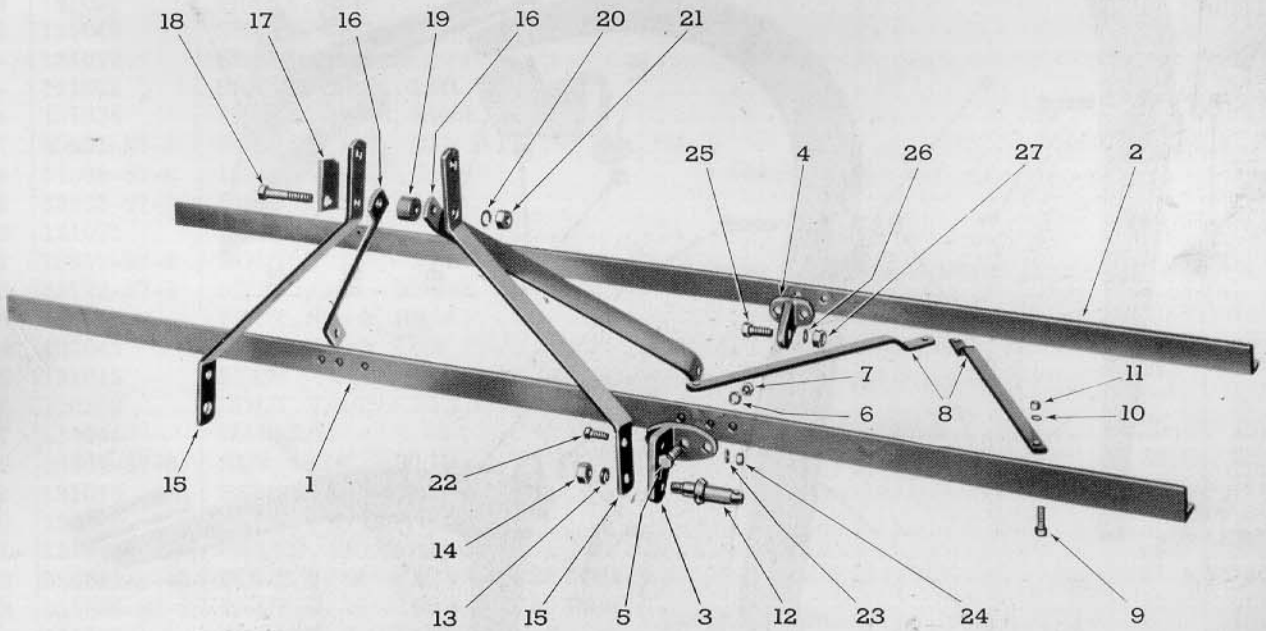

Figure 11 - Frame Assembly

FIG. 11	PART NO.	NAME AND DESCRIPTION	QTY. REQ.
Group 2-1—FRAME ASSEMBLY (Model 13-15)			
1	131000	BAR, Tool, Front	1
2	131208	BAR, Tool, Rear	1
-	131001	BRACKET, Right Front	1
3	131002	BRACKET, Left Front	1
4	131003	BRACKET, Rear	2
5	20453-S7-8	BOLT, 1/2" - 20 x 1-3/8" Hex. Hd.	} Brackets to Tool Bar
6	34809-S7-8	LOCKWASHER, 1/2"	
7	33846-S7-8	NUT, 1/2" - 20 Hex.	
8	131004	BRACE, Front to Rear Tool Bar	4
9	20431-S7-8	BOLT, 7/16" - 20 x 1-1/4" Hex. Hd.	} Brace to Tool Bar
10	34808-S7-8	LOCKWASHER, 7/16"	
11	33802-S7-8	NUT, 7/16" - 20 Hex.	
12	131010	PIN, Link	2
13	34811-S7-8	LOCKWASHER, 5/8"	} Link Pin to Bracket and Strut
14	33850-S7-8	NUT, 5/8" - 18 Hex.	
15	131005	STRUT, Front	2
16	131007	STRUT, Rear	2
17	131009	LOCATOR, Link Pin	1
18	21137-S7-8	BOLT, 5/8" - 18 x 3-1/2" Hex. Hd.	} Front to Rear Strut
19	131008	SPACER	
20	34811-S7-8	LOCKWASHER, 5/8"	
21	33850-S7-8	NUT, 5/8" - 18 Hex.	} Front Strut to Front Bracket
22	20451-S7-8	BOLT, 7/16" - 20 x 1-3/8" Hex. Hd.	
23	34808-S7-8	LOCKWASHER, 7/16"	
24	33802-S7-8	NUT, 7/16" - 20 Hex.	} Rear Strut to Rear Bracket
25	21038-S7-8	BOLT, 5/8" - 18 x 1-11/16" Hex Hd.	
26	34811-S7-8	LOCKWASHER, 5/8"	
27	33850-S7-8	NUT, 5/8" - 18 Hex. Hd.	2

DEARBORN RIGID SHANK *Cultivators*

MODELS 13-1 and 13-3

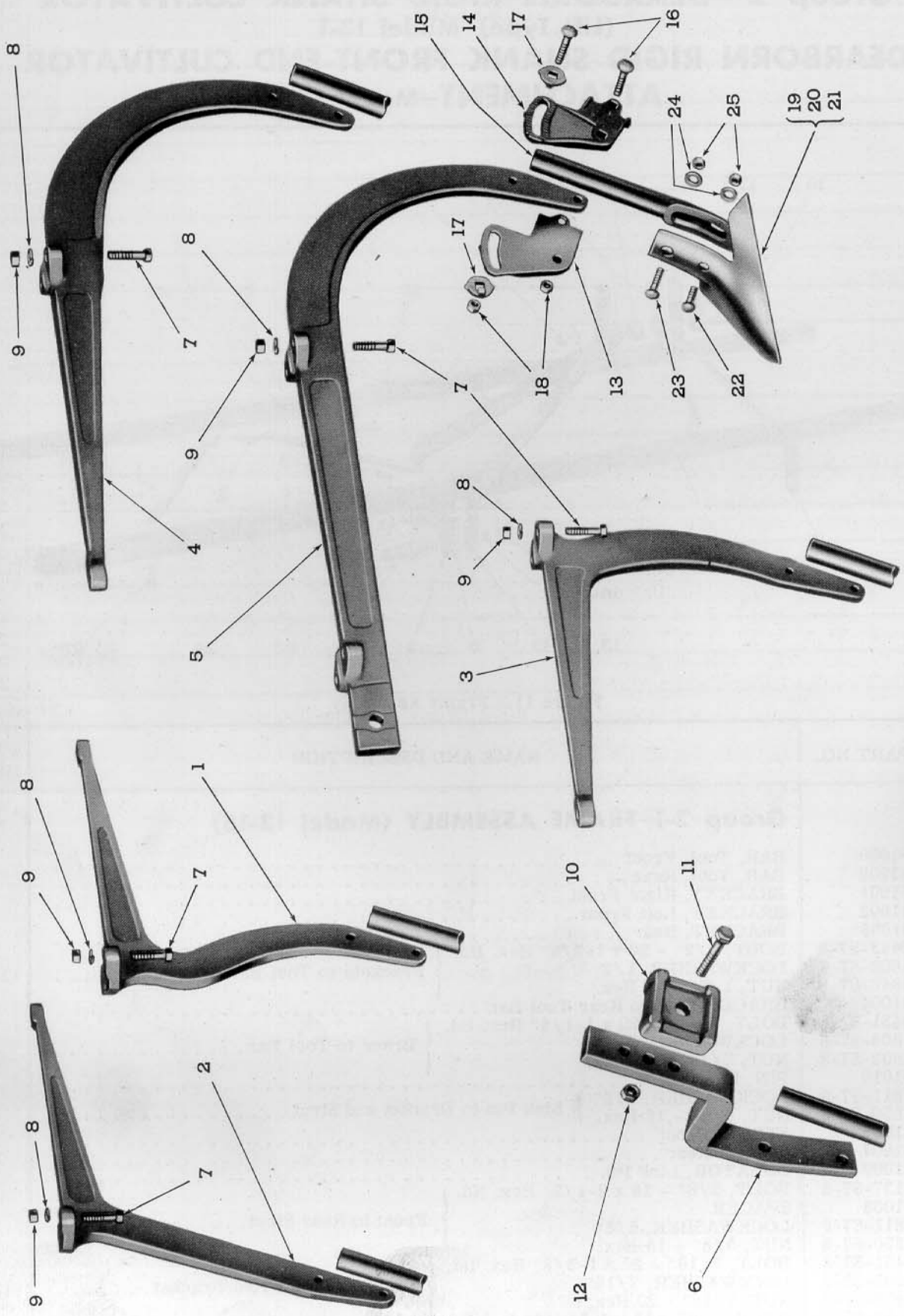

Figure 12 - Shank Assemblies

DEARBORN RIGID SHANK *Cultivators*

MODELS 13-1 and 13-3

FIG. 12	PART NO.	NAME AND DESCRIPTION	QTY. REQ.	
			13-1	13-3
Group 2-2—SHANK ASSEMBLIES				
1	131037	SHANK, Outer Front	2	-
2	131041	SHANK, Inner Front	2	-
3	131038	SHANK, Middle	4	4
4	131039	SHANK, Rear	2	2
5	131040	SHANK, Center	1	1
-	131072	SHANK, Straight	-	2
-	131073	SHANK, Offset, Left	-	1
6	131074	SHANK, Offset, Right	-	1
7	20501-S7-8	BOLT, 7/16" - 20 x 1-11/16" Hex. Hd. } Shank to Tool Bar	34	22
8	34808-S7-8	LOCKWASHER, 7/16" }		
9	33802-S7-8	NUT, 7/16" - 20 Hex. }		
10	131071	BLOCK, Shank	--	4
11	20547-S7-8	BOLT, 7/16" - 20 x 2-1/2" Hex. Hd. } Shank and Block to Beam	--	4
12	33792-S7-8	NUT, 7/16" - 20 Hex. }		
13	131042	FOOT, Shank, Right	11	11
14	131043	FOOT, Shank, Left	11	11
15	131045	STEM	11	11
16	300359	BOLT, 7/16" - 20 x 2-1/8" Carr. } Foot and Stem to Shank	33	33
17	131044	WASHER }		
18	33802-S7-8	NUT, 7/16" - 20 Hex. }		
19	131019	SWEEP, 6" Universal	4	4
20	131020	SWEEP, 8" Universal	4	4
21	131021	SWEEP, 10" Universal	3	3
22	355642-S7-8	BOLT, 7/16" - 20 x 1-1/2" Plow } Sweep to Stem	11	11
23	355665-S7-8	BOLT, 7/16" - 20 x 1-7/8" Plow }		
24	131033	WASHER, 7/16" Plain }		
25	33802-S7-8	NUT, 7/16" - 20 Hex. }	22	22

See GROUP 6 For Ground Engaging Parts

DEARBORN RIGID SHANK *Cultivators*

MODELS 13-1 and 13-3

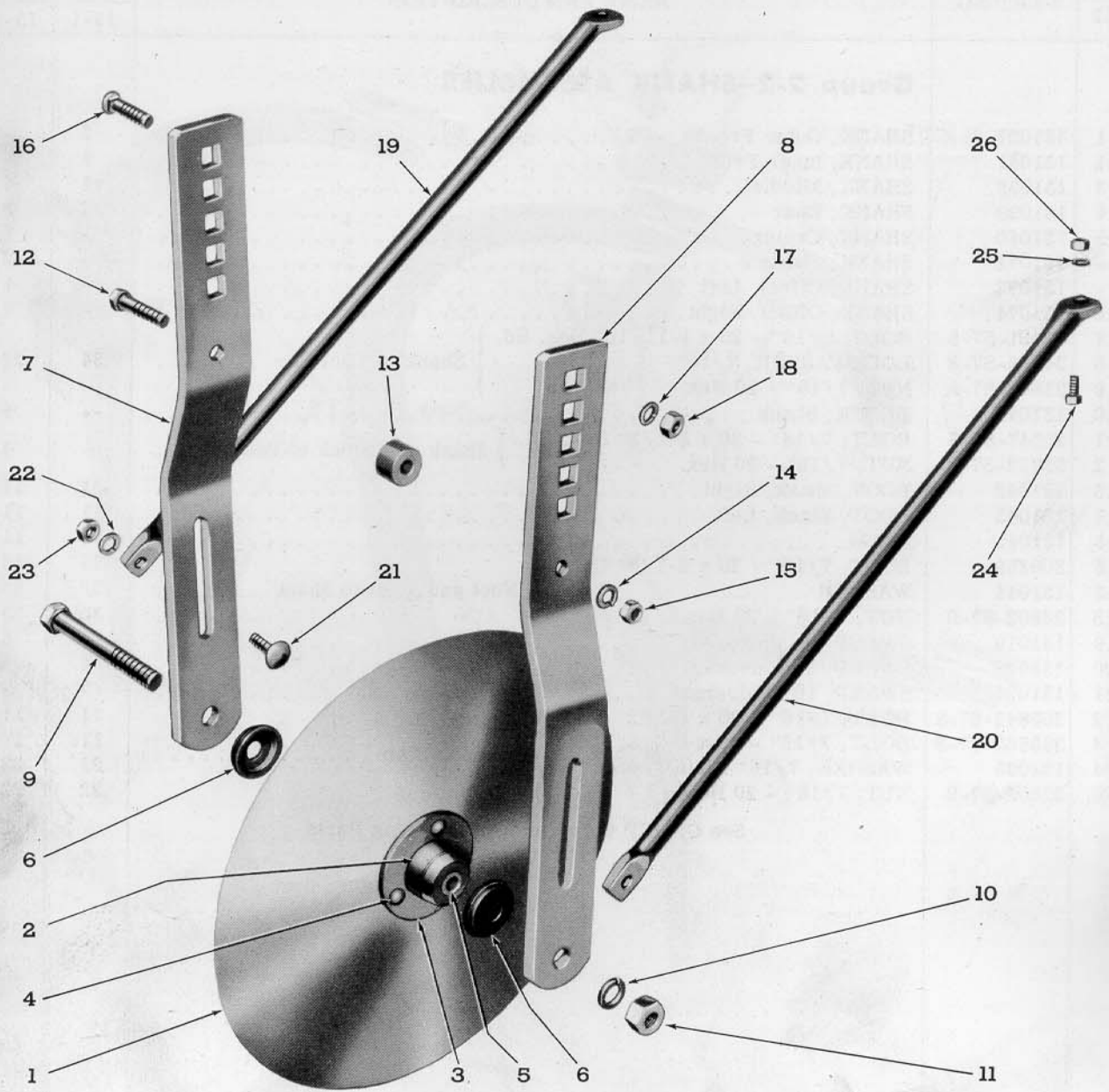

Figure 13 - Rolling Fin Assembly

FIG. 13	PART NO.	NAME AND DESCRIPTION	QTY. REQ.
		Group 2-3-ROLLING FIN ASSEMBLY	
-	131213	ROLLING FIN ASSEMBLY	1
-	131150	Consists of: DISC, HUB and SEAL ASSEMBLY, 18" Plain	1
1	103052	Consists of: DISC	1
2	131214	HUB	1
3	103053	FLANGE	1
4	61581-S	RIVET, 5/16" x 1-3/8" Button Hd. - Flange to Hub	3
-	300273	FITTING, Hub Lube	1

DEARBORN RIGID SHANK *Cultivators*

MODELS 13-1 and 13-3

FIG. 13	PART NO.	NAME AND DESCRIPTION	QTY. REQ.
Group 2-3—ROLLING FIN ASSEMBLY (Cont'd)			
5	131219	SLEEVE, Disc Hub Bearing	1
6	131215	SEAL ASSEMBLY, Dust	1
-	103048	DISC and HUB ASSEMBLY, 15-1/2" Plain	1
		Consists of:	
-	103051	DISC	1
-	103050	HUB	1
-	103053	FLANGE	1
-	60532-S7-8	RIVET, 5/16" x 1-3/8" Rd. Hd. - Flange to Hub	3
-	353027-S7-8-A1	FITTING, Hub Lube	1
-	131032	SLEEVE, Disc Hub Bearing (15-1/2")	1
-	131031	CAP. Dust (15-1/2")	2
7	131027	ARM, Support, Right	1
8	131028	ARM, Support, Left	1
9	22084-S7-8	BOLT, 5/8" - 18 x 4-3/4" Hex. Hd. }	1
10	34811-S7-8	LOCKWASHER, 5/8" } Support Arms to Disc and Hub	
11	33850-S7-8	NUT, 5/8" - 18 Hex. }	1
12	20525-S7-8	BOLT, 7/16" - 20 x 2" Hex. Hd. } Right to Left Support Arm	
13	131090	SPACER }	1
14	34808-S7-8	LOCKWASHER, 7/16" } Support Arms to Shank	
15	33802-S7-8	NUT, 7/16" - 20 Hex. }	1
16	23554-S7-8	BOLT, 5/8" - 18 x 2-1/2" Carr. } Support Arms to Shank	
17	34811-S7-8	LOCKWASHER, 5/8" }	1
18	33850-S7-8	NUT, 5/8" - 18 Hex. }	
19	131091	BRACE, Stay, Right	1
20	131092	BRACE, Stay, Left	1
21	23443-S7-8	BOLT, 7/16" - 20 x 1-1/4" Carr. }	2
22	34808-S7-8	LOCKWASHER, 7/16" } Brace to Support Arm	
23	33802-S7-8	NUT, 7/16" - 20 Hex. }	2
24	20431-S7-8	BOLT, 7/16" - 20 x 1-1/4" Hex. Hd. } Brace to Tool Bar	
25	34808-S7-8	LOCKWASHER, 7/16" }	
26	33802-S7-8	NUT, 7/16" - 20 Hex. }	

DEARBORN RIGID SHANK *Cultivators*

MODELS 13-1 and 13-3

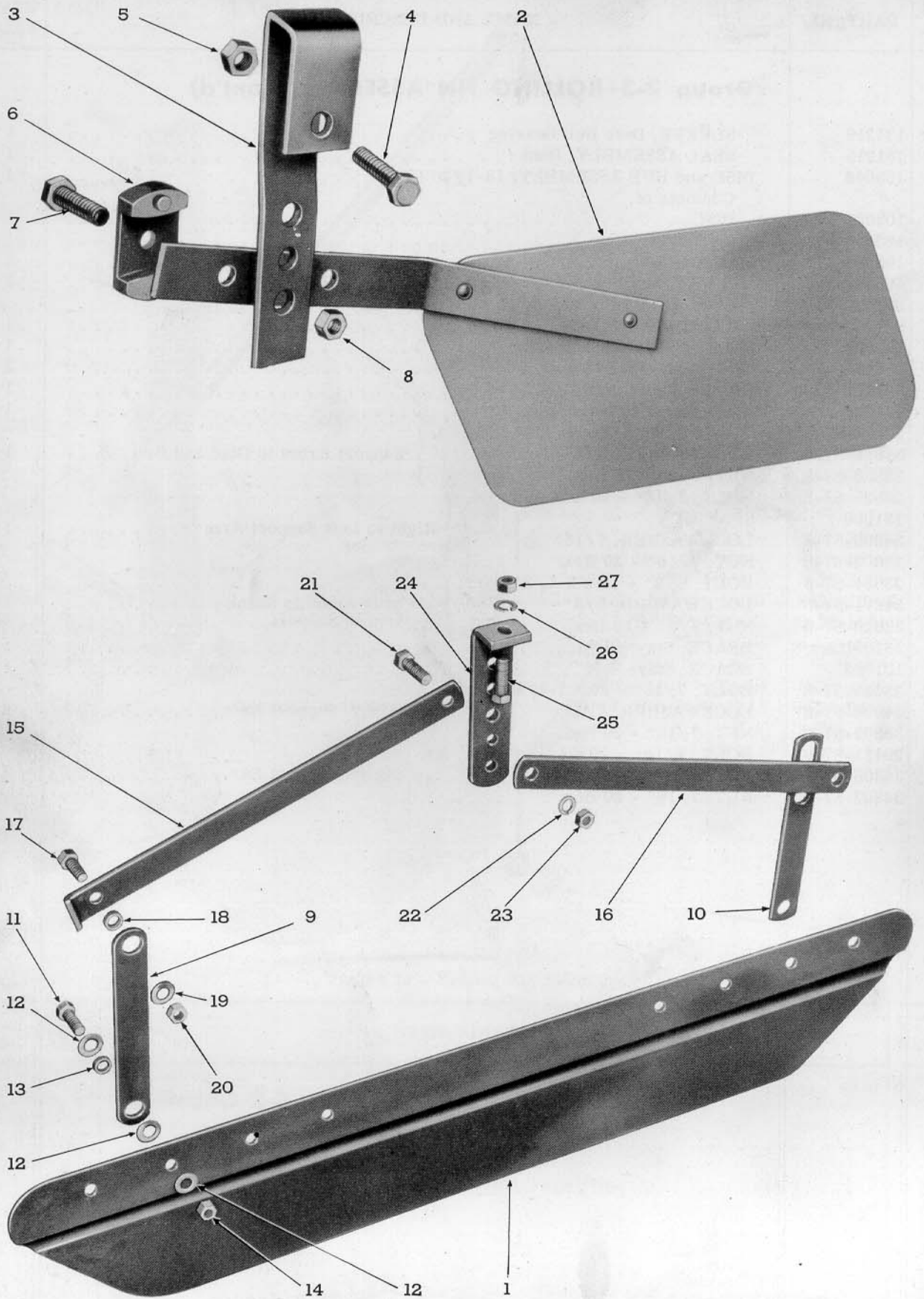

Figure 14 - Shield Assemblies

DEARBORN RIGID SHANK *Cultivators*

MODELS 13-1 and 13-3

FIG. 14	PART NO.	NAME AND DESCRIPTION	QTY. REQ.	
			13-1	13-3
Group 2-4—SHIELD ASSEMBLIES				
1	131011	SHIELD	4	-
-	131082	SHIELD, Left (Riveted Assembly)	-	2
2	131083	SHIELD, Right (Riveted Assembly)	-	2
-	131084	SUPPORT, Shield, Left	-	2
3	131085	SUPPORT, Shield, Right	-	2
4	20525-S7-8	BOLT, 7/16" - 20 x 2" Hex. Hd. } Support to Beam	-	4
5	33792-S7-8	NUT, 7/16" - 20 Hex. }	-	4
6	131086	BLOCK	-	4
7	20471-S7-8	BOLT, 7/16" - 20 x 1-1/2" Hex. Hd. } Block and Shield to Support . . .	-	4
8	33792-S7-8	NUT, 7/16" - 20 Hex. }	-	4
9	131015	LINK, Toggle, Front	4	-
10	131016	LINK, Toggle, Rear	4	-
11	20391-S7-8	BOLT, 7/16" - 20 x 1" Hex. Hd. } Link to Shield	8	-
12	34748-S7-8	WASHER, 7/16" Plain }	24	-
13	131017	SPACER }	8	-
14	33802-S7-8	NUT, 7/16" - 20 Hex. }	8	-
15	131013	ARM, Shield, Front	4	-
16	131014	ARM, Shield, Rear	4	-
17	20391-S7-8	BOLT, 7/16" - 20 x 1" Hex. Hd. } Arm to Link	8	-
18	131017	SPACER }	8	-
19	34748-S7-8	WASHER, 7/16" Plain }	8	-
20	33802-S7-8	NUT, 7/16" - 20 Hex. }	8	-
21	20451-S7-8	BOLT, 7/16" - 20 x 1-3/8" Hex. Hd. } Arm to Support	4	-
22	34808-S7-8	LOCKWASHER, 7/16" }	4	-
23	33802-S7-8	NUT, 7/16" - 20 Hex. }	4	-
24	131012	SUPPORT, Shield Arm	4	-
25	20431-S7-8	BOLT, 7/16" - 20 x 1-1/4" Hex. Hd. } Support to Tool Bar	4	-
26	34808-S7-8	LOCKWASHER, 7/16" }	4	-
27	33802-S7-8	NUT, 7/16" - 20 Hex. }	4	-

DEARBORN RIGID SHANK *Cultivators*

MODELS 13-1 and 13-3

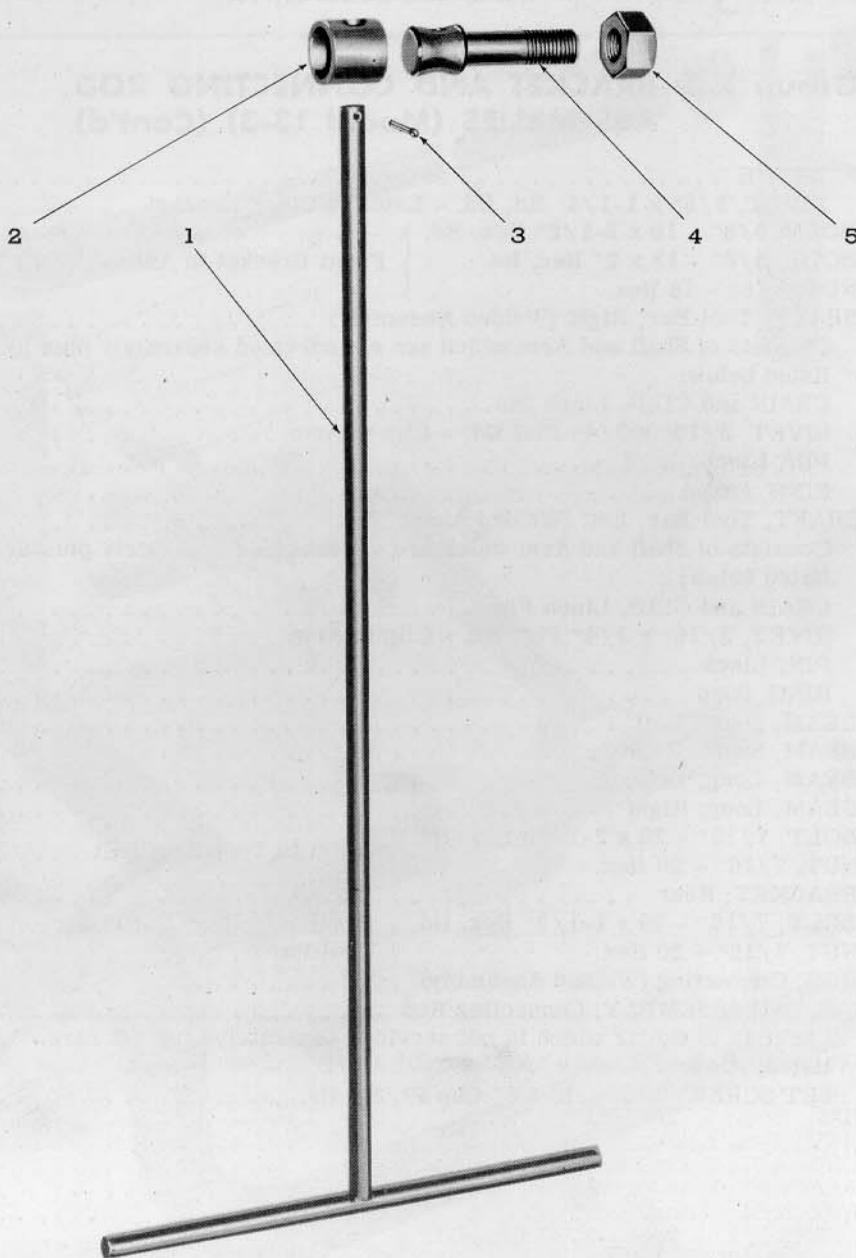

Figure 16 - Steering Pointer Assembly

FIG. 16	PART NO.	NAME AND DESCRIPTION	QTY. REQ.
Group 2-6—STEERING POINTER ASSEMBLY			
1	131203	ARM, Steering Pointer	1
2	131202	SLEEVE	1
3	72034-S7-8	COTTER PIN, 3/32" x 1"	1
4	131201	BOLT	1
5	33850-S7-8	NUT, 5/8" - 18 Hex. } Arm to Tractor Front Axle.	1

DEARBORN GROUND ENGAGING PARTS FOR RIGID AND SPRING SHANK CULTIVATORS

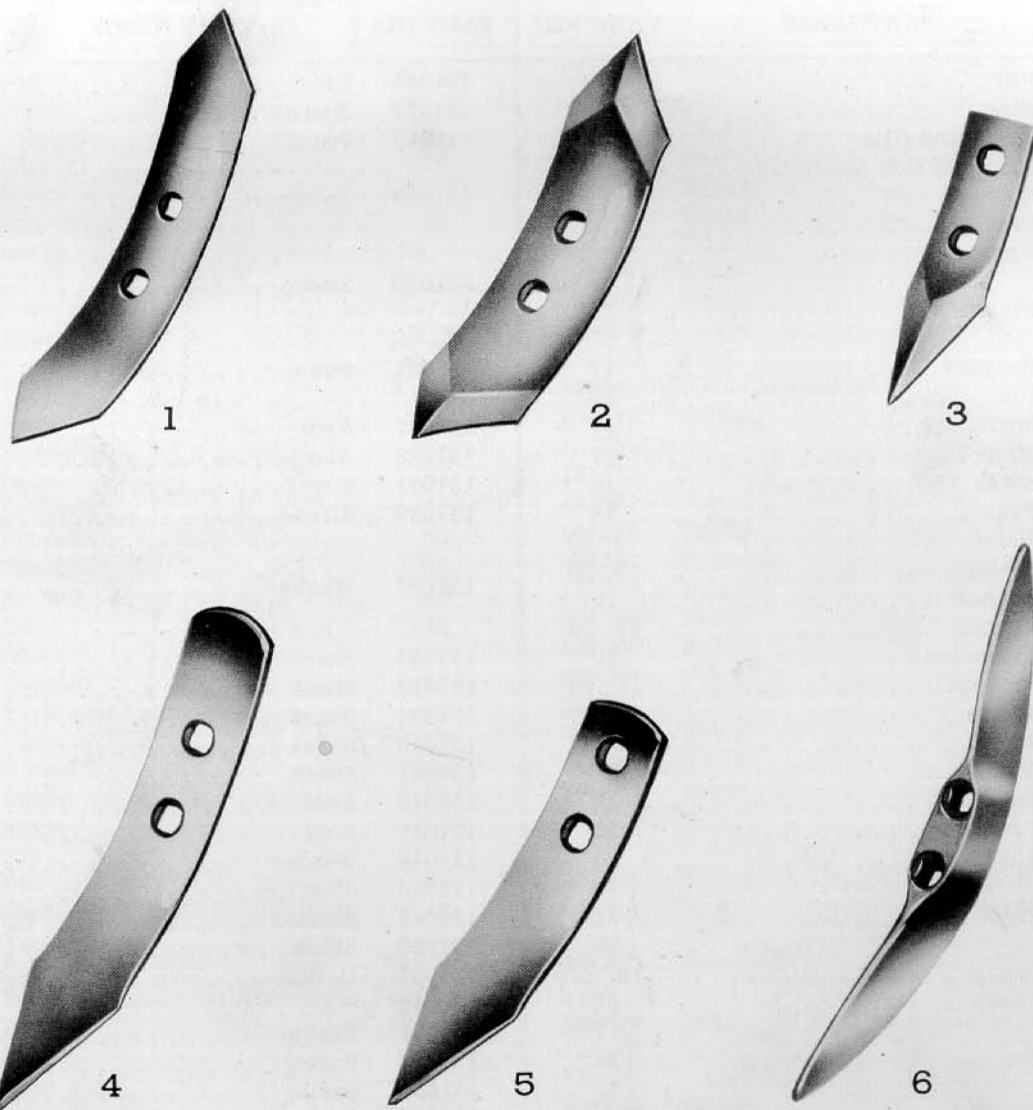

Figure 30 - Points and Teeth

FIG. 30	PART NO.	NAME AND DESCRIPTION	QTY. REQ.
Group 6-3—POINTS AND TEETH			
1	103305	POINT, Reversible, 5/16" x 2" x 10-1/2"	As Req.
2	131018	POINT, Reversible, 5/16" x 2-1/2" x 10-1/2"	As Req.
3	131569	POINT, Plain, 1/4" x 1-3/4" x 6-1/2"	As Req.
4	131568	POINT, Flat Face, 5/16" x 2" x 11"	As Req.
5	131590	POINT, Flat Face, 5/16" x 2" x 10"	As Req.
6	132023	TOOTH, Alfalfa	As Req.

DEARBORN GROUND ENGAGING PARTS FOR RIGID AND SPRING SHANK CULTIVATORS

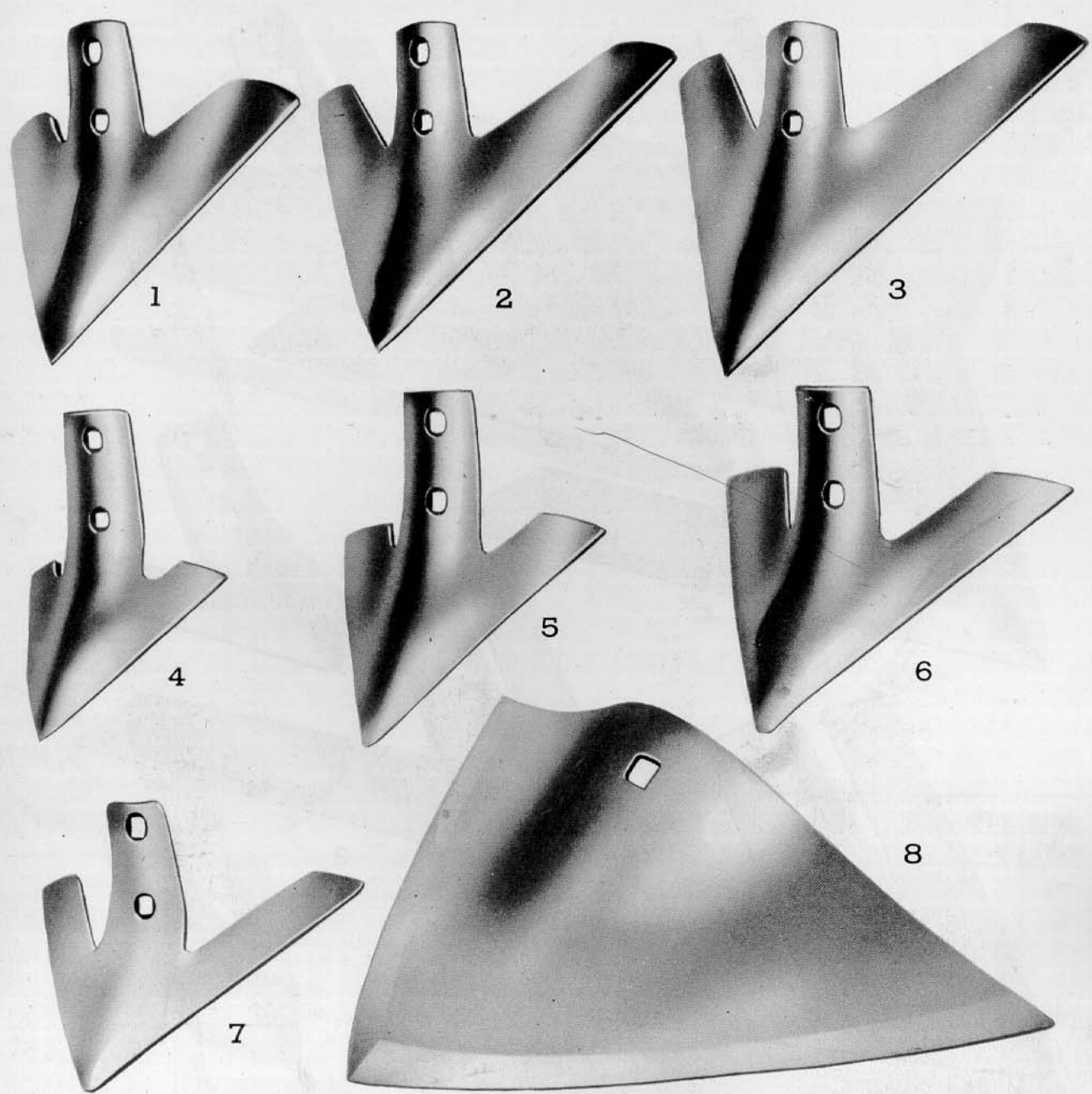

Figure 29 - Duckfoot, Low Crown and Miscellaneous Sweeps

FIG. 29	PART NO.	NAME AND DESCRIPTION	QTY. REQ.
Group 6-2—DUCKFOOT, LOW CROWN AND MISCELLANEOUS SWEEPS			
1	131671	SWEEP, Duckfoot, 1/4" x 10"	As Req.
2	131672	SWEEP, Duckfoot, 1/4" x 12"	As Req.
3	131730	SWEEP, Duckfoot, 1/4" x 14"	As Req.
4	131019	SWEEP, Low Crown, 3/16" x 6"	As Req.
5	131020	SWEEP, Low Crown, 3/16" x 8"	As Req.
6	131021	SWEEP, Low Crown, 3/16" x 10"	As Req.
7	131802	SWEEP, Low Crown, High Speed, 3/16" x 6"	As Req.
-	131803	SWEEP, Low Crown, High Speed, 3/16" x 8"	As Req.
-	131804	SWEEP, Low Crown, High Speed, 3/16" x 10"	As Req.
8	120781	SWEEP, Mr. Bill Planter, 20" www.tractorclub.com	As Req.

Group 6—DEARBORN GROUND ENGAGING PARTS FOR RIGID AND SPRING SHANK CULTIVATORS



Figure 28 - Universal Sweeps

FIG. 28	PART NO.	NAME AND DESCRIPTION	QTY. REQ.
Group 6-1—UNIVERSAL SWEEPS			
1	131280	SWEEP, Universal, 1/4" x 12"	As Req.
2	131281	SWEEP, Universal, 1/4" x 14"	As Req.
3	131282	SWEEP, Universal, 1/4" x 16"	As Req.
4	131283	SWEEP, Universal, 1/4" x 18"	As Req.
5	131284	SWEEP, Universal, 1/4" x 20"	As Req.
6	131800	SWEEP, Universal, Left Half, 1/4" x 10"	As Req.
7	131801	SWEEP, Universal, Right Half, 1/4" x 10"	As Req.
8	131820	SWEEP, Universal, (Soft Center Steel) 1/4" x 9"	As Req.
8	131821	SWEEP, Universal (Crucible Steel) 1/4" x 9"	As Req.